

e. 3

LA-3446

CIC-14 REPORT COLLECTION
**REPRODUCTION
COPY**

LOS ALAMOS SCIENTIFIC LABORATORY
of the
University of California
LOS ALAMOS • NEW MEXICO

Gamma Dose Rate Measurements --
Kiwi Transient Nuclear Test



UNITED STATES
ATOMIC ENERGY COMMISSION
CONTRACT W-7405-ENG. 36

LEGAL NOTICE

This report was prepared as an account of Government sponsored work. Neither the United States, nor the Commission, nor any person acting on behalf of the Commission:

A. Makes any warranty or representation, expressed or implied, with respect to the accuracy, completeness, or usefulness of the information contained in this report, or that the use of any information, apparatus, method, or process disclosed in this report may not infringe privately owned rights; or

B. Assumes any liabilities with respect to the use of, or for damages resulting from the use of any information, apparatus, method, or process disclosed in this report.

As used in the above, "person acting on behalf of the Commission" includes any employee or contractor of the Commission, or employee of such contractor, to the extent that such employee or contractor of the Commission, or employee of such contractor prepares, disseminates, or provides access to, any information pursuant to his employment or contract with the Commission, or his employment with such contractor.

This report expresses the opinions of the author or authors and does not necessarily reflect the opinions or views of the Los Alamos Scientific Laboratory.

Printed in USA. Price \$2.00. Available from the Clearinghouse for Federal Scientific and Technical Information, National Bureau of Standards, United States Department of Commerce, Springfield, Virginia

LOS ALAMOS SCIENTIFIC LABORATORY
of the
University of California
LOS ALAMOS • NEW MEXICO

Report written: December 1965

Report distributed: March 29, 1966

Gamma Dose Rate Measurements --
Kiwi Transient Nuclear Test

Work performed by:

W. H. Schweitzer
P. K. Lee
T. R. VanLyssel
F. W. Sanders

Report written by:

Fred W. Sanders

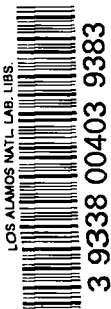

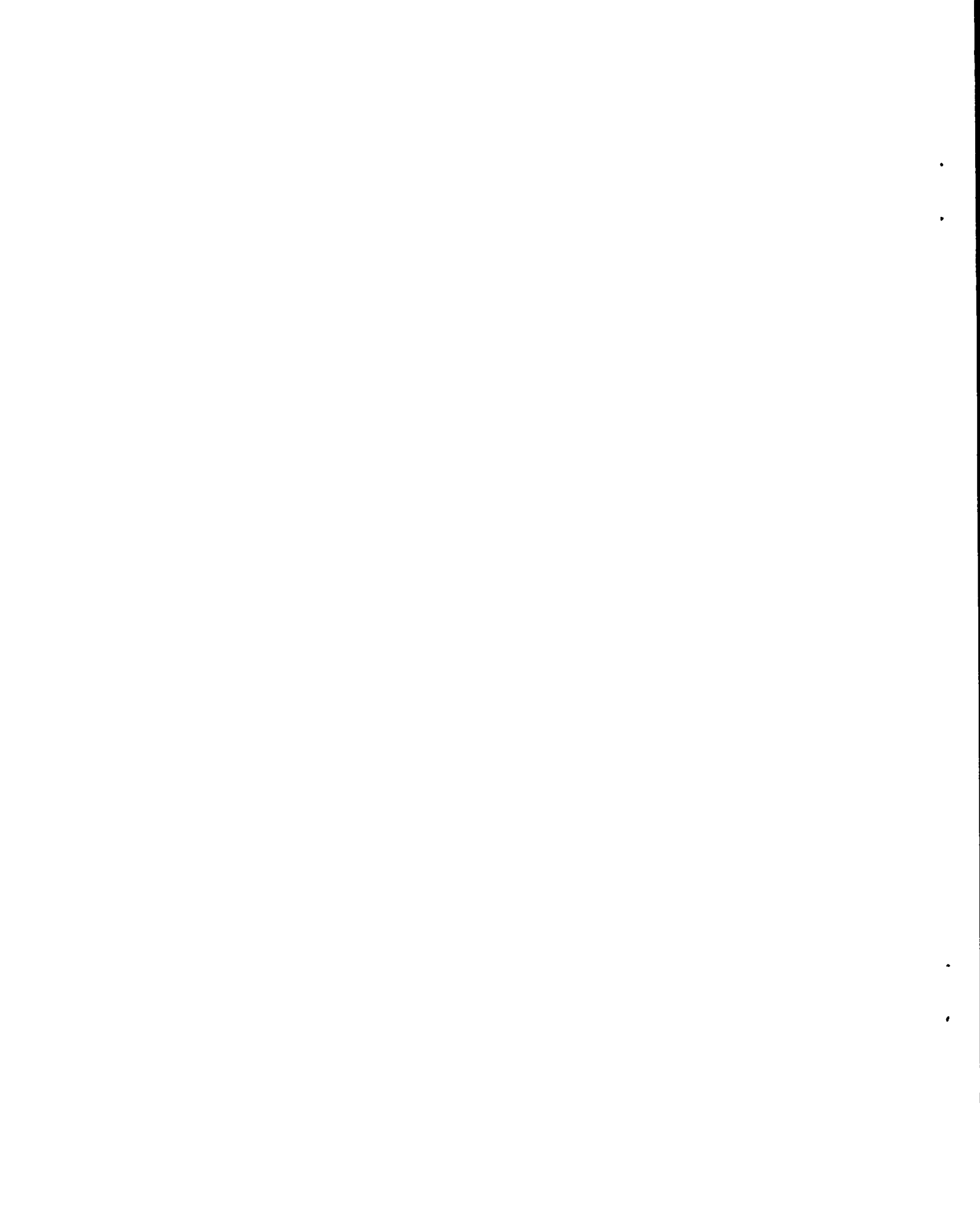

ABSTRACT

Group H-8 of the Los Alamos Scientific Laboratory's Health Division measured gamma-ray dose rates after the destruction test of a prototype nuclear rocket reactor which was designated the Kiwi Transient Nuclear Test. Dose rates were measured around the test point out to 500 feet and in the downwind direction out to 8,000 feet. It was found that even as close as 100 feet from the test point dose rates were affected by wind direction. The passage of the effluent cloud was observed at 4,000 and 8,000 feet. Isodose rate contours were determined at several post-event times, and estimates of integrated dose to personnel making emergency entries were prepared.

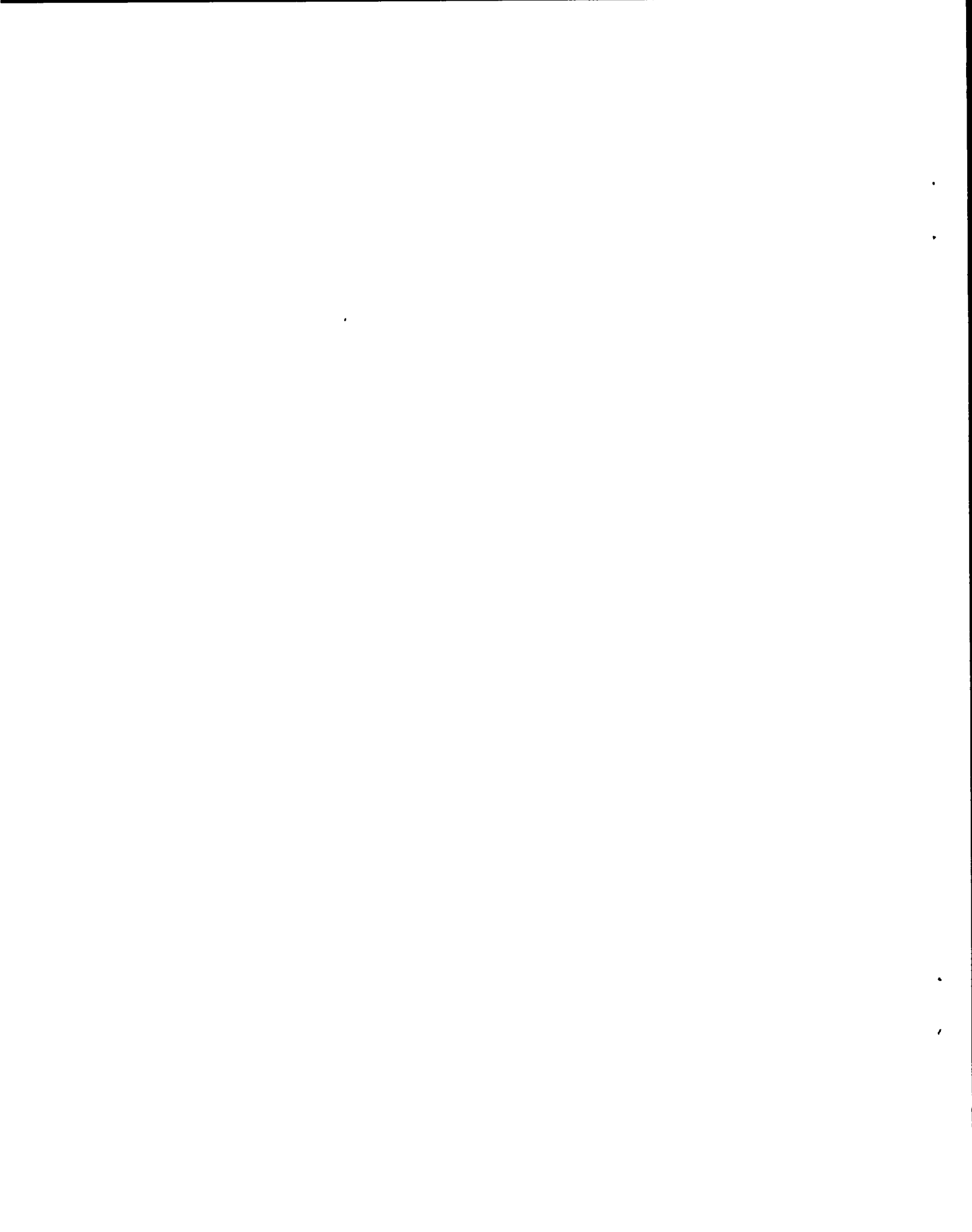

CONTENTS

	<u>Page</u>
Abstract	3
Introduction	7
Methods	10
Results	19
Discussion	30
Conclusions	34
References	35

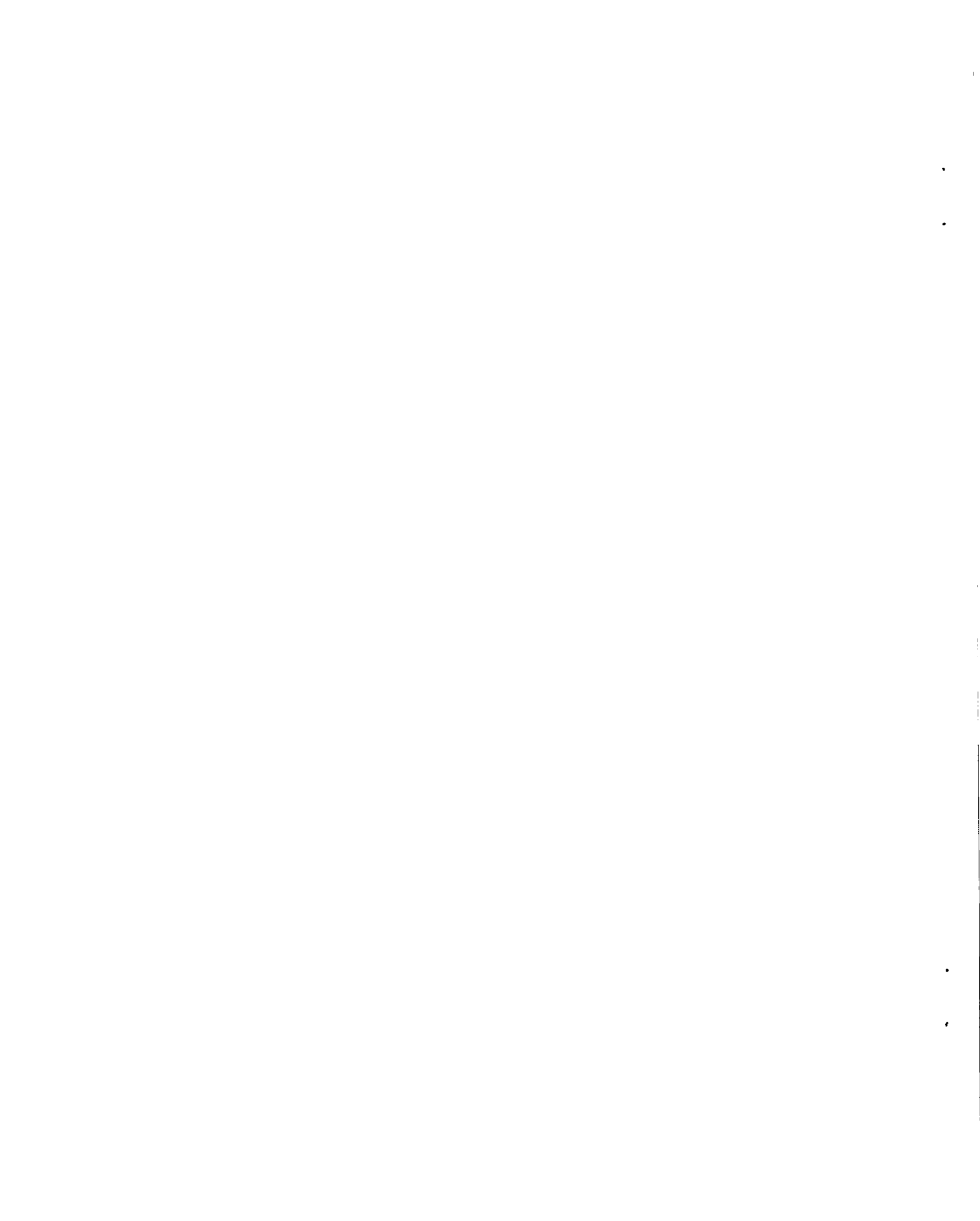

INTRODUCTION

The Kiwi Transient Nuclear Test (TNT) was a successful nuclear destruction test of a slightly modified Kiwi B4 reactor. This experiment, which was conducted by the Los Alamos Scientific Laboratory (LASL) at the Nuclear Rocket Development Station in Nevada, was designed to provide information on the mechanical, thermodynamic, and neutronic characteristics of the reactor transient and to provide information on the hazards produced by such a transient. These hazards include prompt radiation from the reactor and radiation from the remains and from the effluent cloud.

The Kiwi TNT reactor (Fig. 1) was constructed primarily of B4-type reactor parts; however, some systems were modified or deleted. Since there was no need for cooling the reactor, there was no provision for propellant flow. The nozzle was omitted and replaced by a large mirror which was used to obtain photographs of the end of the core during the transient. A remotely controlled system was installed to insert or remove boral poison vanes. The reactivity of the reactor was adjusted so that with the boral neutron absorbers in the "out" position and the control drums in the "in" position the reactor was slightly subcritical. The control drum actuators were modified to rotate the control drums at about 100 times the normal maximum rate.

The test point for the TNT event (Fig. 2) was located about 640 feet northwest of Test Cell C, at a place where the railroad crosses a large wash on an earth fill. The height of the fill above the bottom of the wash at the test point was about 45 feet. The direction of the wash was generally north-south for a few hundred feet on each side of the fill.

On January 12, 1965, the boral vanes were withdrawn from the reactor, and at 10:57:46 a.m. PST the control drums were actuated producing a $3.1 \pm 0.3 \times 10^{20}$ fission transient lasting a few milliseconds. The reactor was destroyed during the test, as had been expected, and an effluent cloud was produced. This cloud contained 60 to 70 percent of the fission product activity. The effluent cloud traveled in a direction about 210° from north at speeds of from 15 to 25 knots. Pieces of the reactor were scattered over an area several hundred feet in diameter.¹

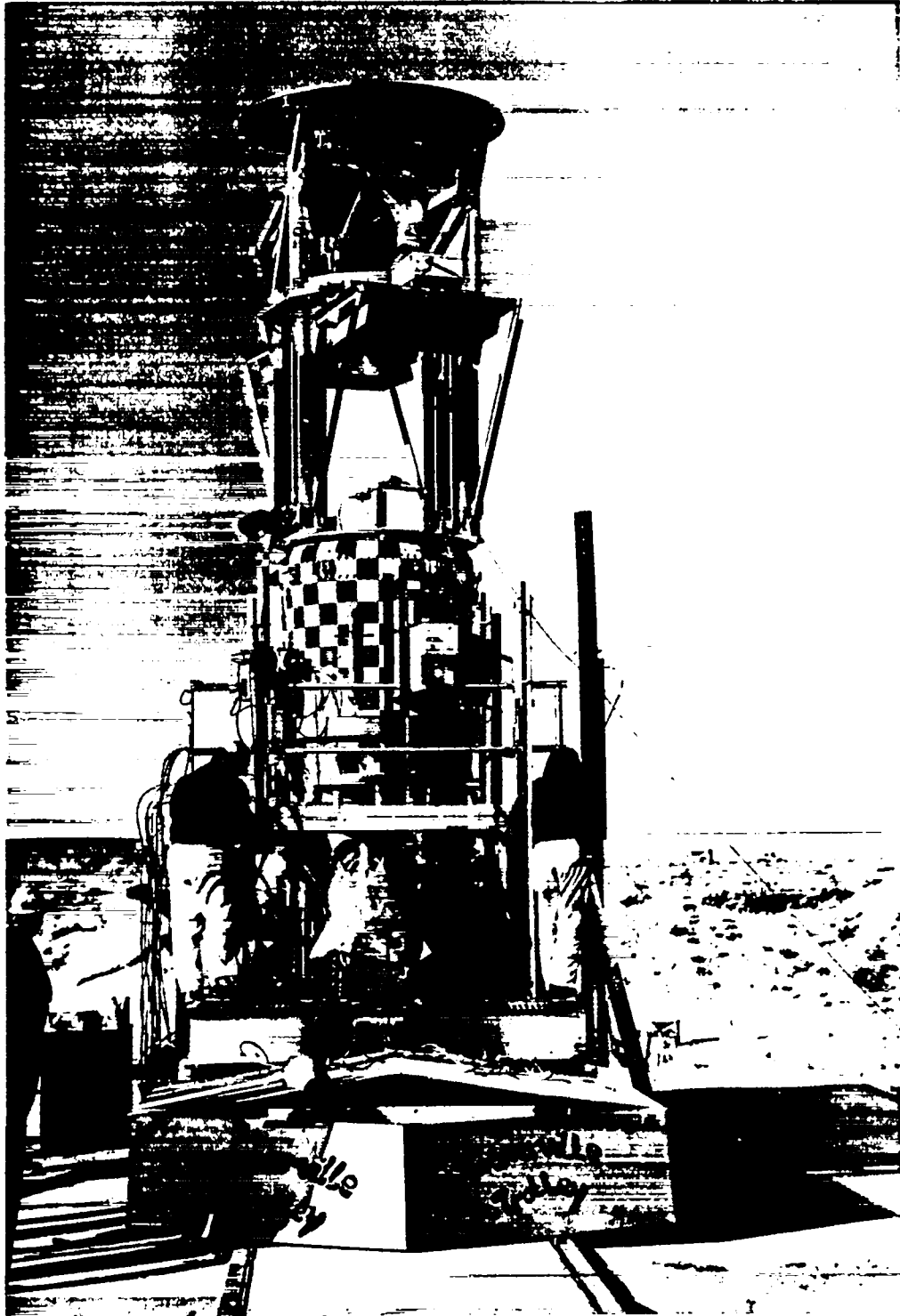

Fig. 1. Kiwi TNT reactor.



Fig. 2. TNT test point.

Group H-8 of the LASL Health Division made documentary measurements of the radioactive effluent, integral radiation doses,² and radiation dose rates of the Kiwi TNT. The gamma-ray dose rates measured near the TNT site are discussed in this report. No attempt was made to measure dose rates during destruction of the reactor. Dose rate values are presented for times from about one minute to several hours after the transient.

METHODS

Instrument Systems

Two instrument systems were used to measure gamma-ray dose rates after the Kiwi TNT event. A photomultiplier/photovoltaic cell scintillator system was used close to the reactor (within 500 feet), and an ionization chamber system was employed at greater distances.

The scintillator system consisted of components that had been tested or used on previous Kiwi reactor tests.³ The scintillating material used was plastic, NE 102 (Nuclear Enterprises, Ltd.). Each piece of the plastic was light-coupled to one photomultiplier (PM) tube (DuMont 6364) or to two photovoltaic (PV) cells (International Rectifier Corp. selenium photocell A30). Power for the PMs was furnished by battery-operated, remotely controlled, high-voltage power supplies; the PV cells required no power. The signal outputs from one PV detector unit and one PM detector unit were connected in parallel to RG 58/U coaxial signal line, thus requiring fewer signal lines. The signal lines were about two miles long and terminated in the H-8 trailer in the Control Point area. Thin aluminum boxes containing one PM detector unit and power supply and one PV detector unit were mounted on 4" x 4" posts at a height of 3 feet above grade (Figs. 3 and 4). The currents from the PMs and PVs were measured with transistorized galvanometers (Kintel Model 204A). The outputs of the galvanometers were connected to strip chart recorders (Varian Associates Model G-11A). Each readout unit was provided with a switch to energize its respective PM detector power supply. Twelve PM/PV units were used (Fig. 5).

A block diagram of the PV/PM system is shown in Fig. 6. The PM and PV detectors provided direct current signals of opposite polarity, which required changing the polarity of the connections to the galvanometers when the PM detectors were energized. The range of a typical PM detector was approximately 60 mR/hr to 10^2 R/hr; that of a typical PV detector was approximately 20 R/hr to 10^4 R/hr. Figure 7 shows the relationship between dose rate and signal current for typical PV and PM



Fig. 3. Closed PM/PV station.



Fig. 4. Open PM/PV station.

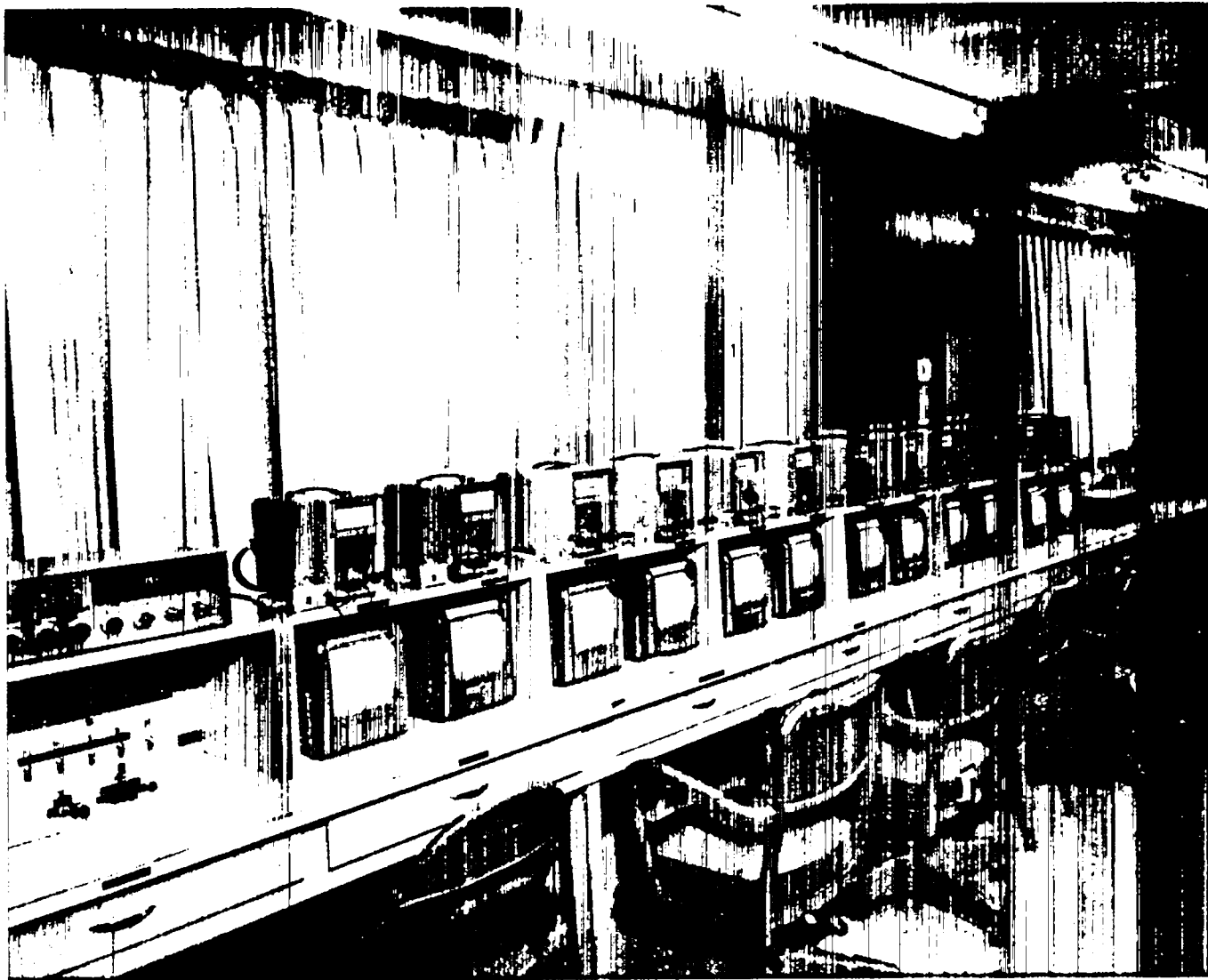

Fig. 5. PM/PV readout units.

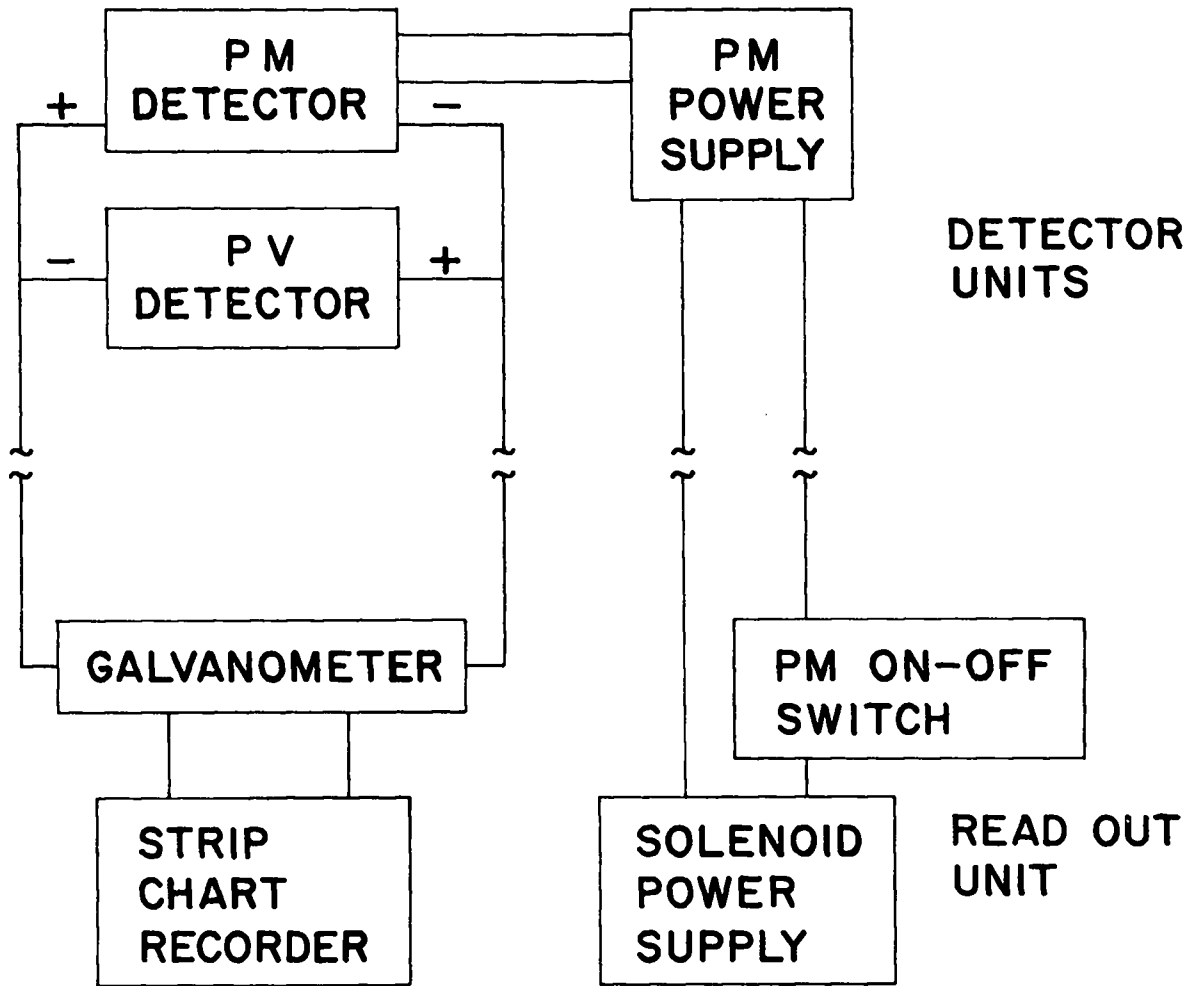

Fig. 6. Block diagram of PV/PM system.

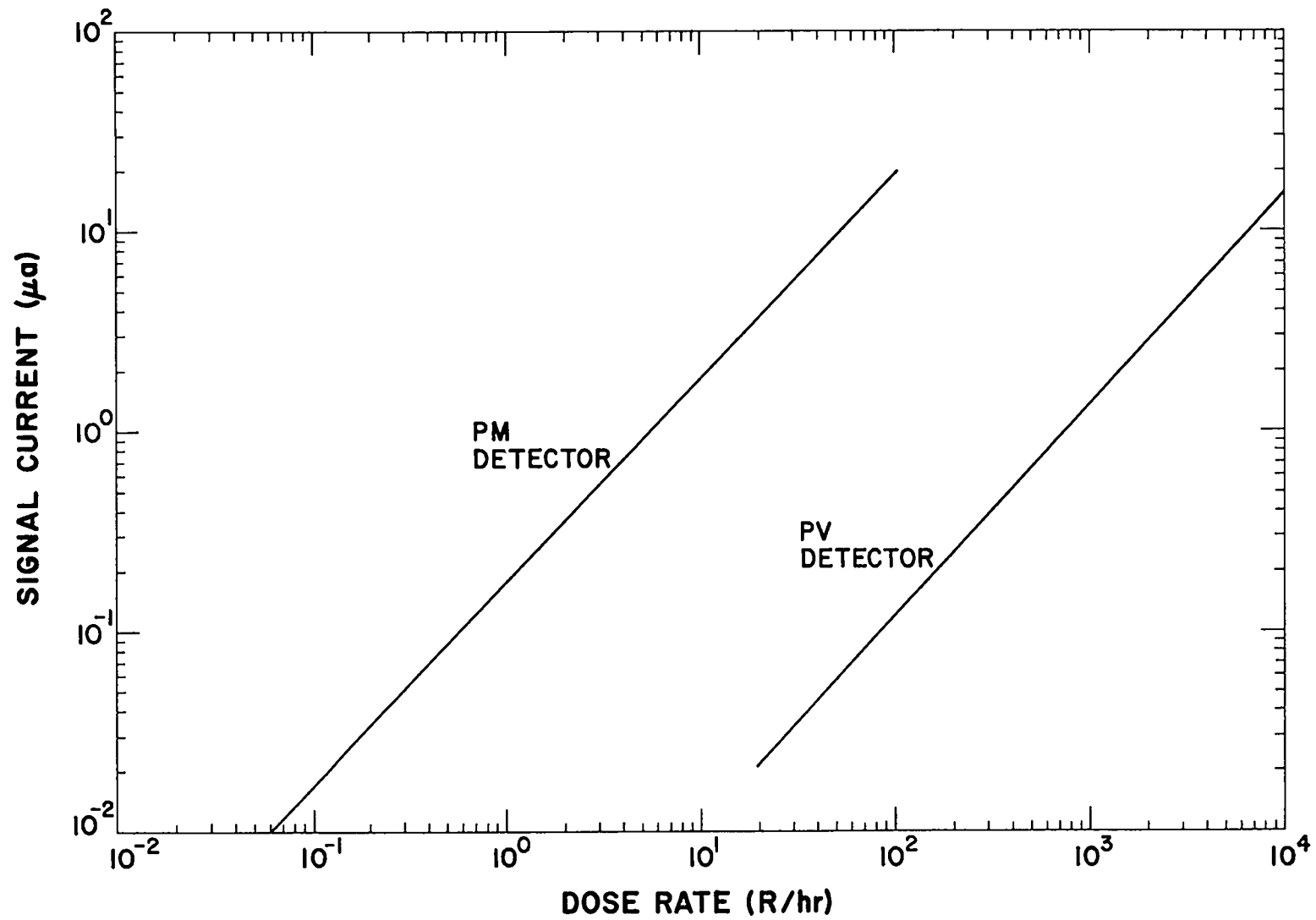

Fig. 7. Response of typical PV and PM detector units.

detector units. In radiation fields greater than 10^2 R/hr, the PM detector power supply was turned off. When the PM detector power supply was turned on, in radiation fields less than 10^2 R/hr, the magnitude of the signal current from the PV detector was approximately 0.6 percent of the magnitude of that from the PM detector. The effect of the PV signal current on the PM signal current was, therefore, negligible.

The ionization chamber system used was commercially obtained (Victoreen Instrument Co., Jordan Electronic Div.). It included probes (Fig. 8) each consisting of a Nehr-White ionization chamber and a battery-operated power supply, and readout units (Fig. 9). The probes and readout units were connected by pairs of signal wires which were generally more than two miles long. Nehr-White ionization chambers contain an electrometer tube (5886), the grid of which is connected only to the collector electrode of the chamber. These chambers respond logarithmically to gamma radiation. The readout units are provided with two ranges, 1 to 10^3 mR/hr and 1 to 10^3 R/hr.

Placement

The 12 PM/PV stations were placed symmetrically about the test point at distances of 100, 200, and 500 feet on each of four azimuths, 0° , 90° , 180° , and 270° (Fig. 10).

The thirty ionization chambers were located as shown in Figs. 10 and 11. Most of these instruments were placed in the sector which the operational requirements of the TNT event designated downwind. Arcs of radii 500, 1,000, and 2,000 feet, centered on the TNT test point, were surveyed for instrument placement; however, existing stations on arcs of radii 4,000 feet and 8,000 feet, centered on Test Cell C, were utilized. Table 1 shows the correlation between the standard Test Cell C designation of a sampling station and the location of the station with reference to the TNT test point.

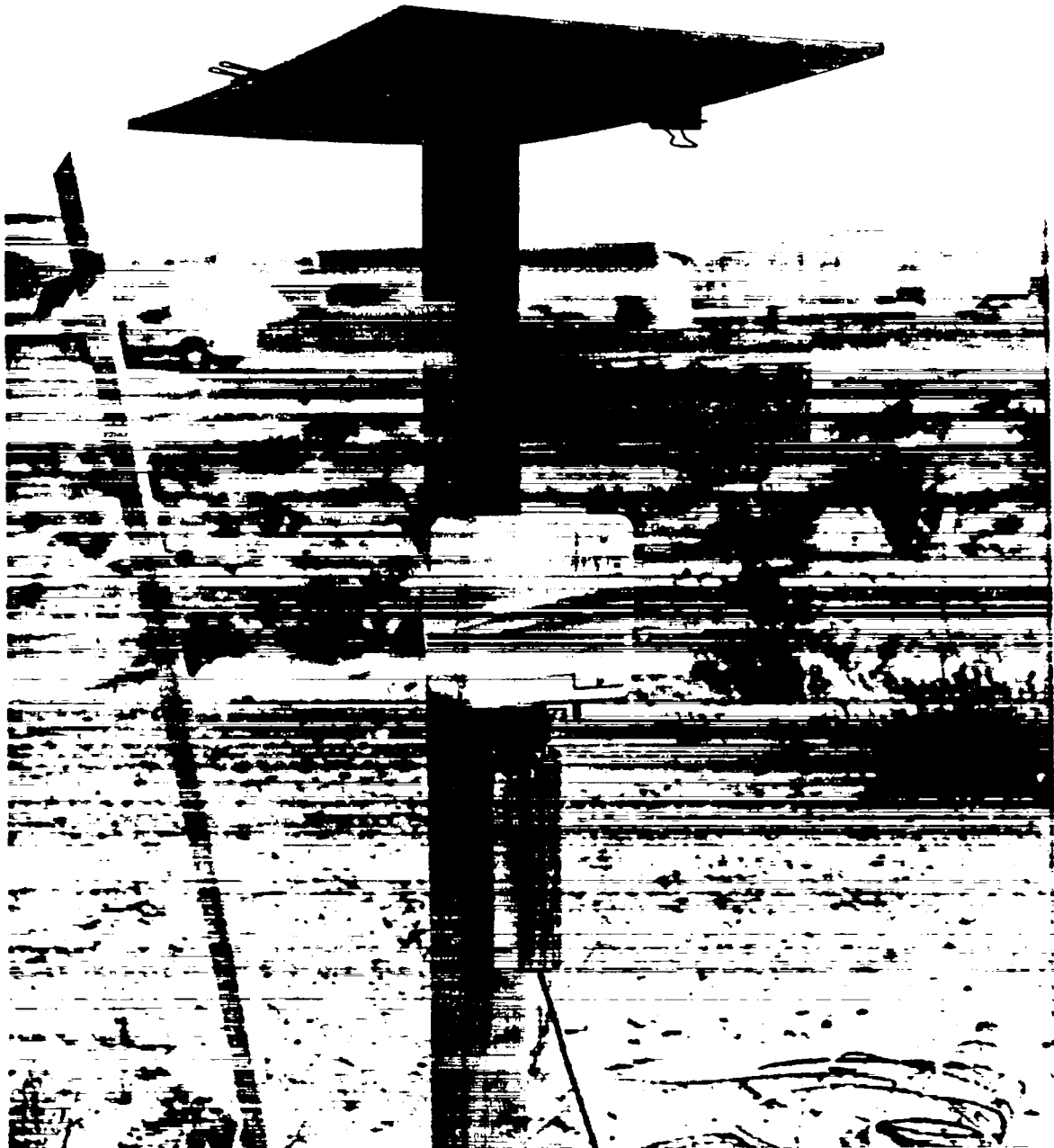

Fig. 8. Ionization chamber station.

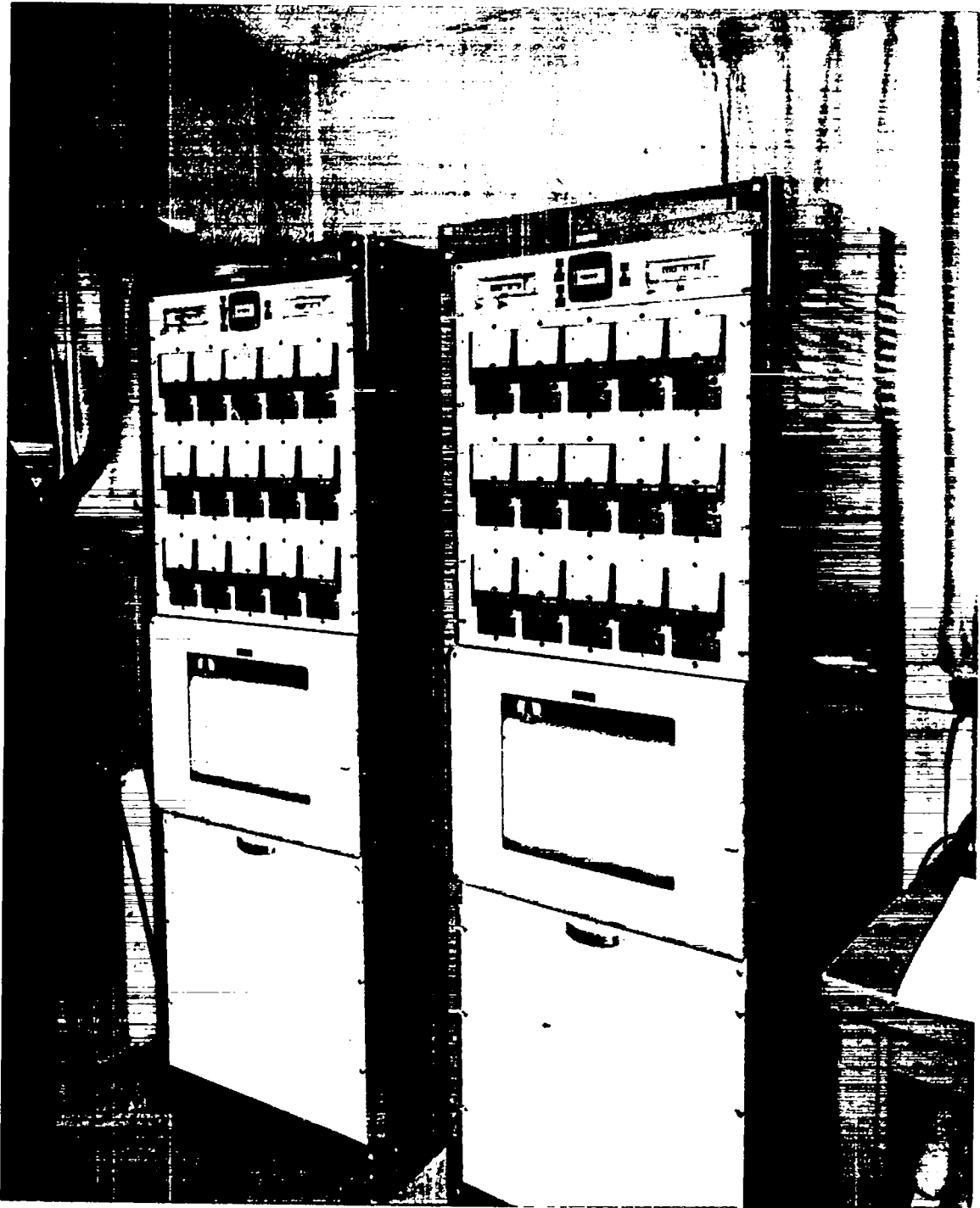

Fig. 9. Ionization chamber readout units.

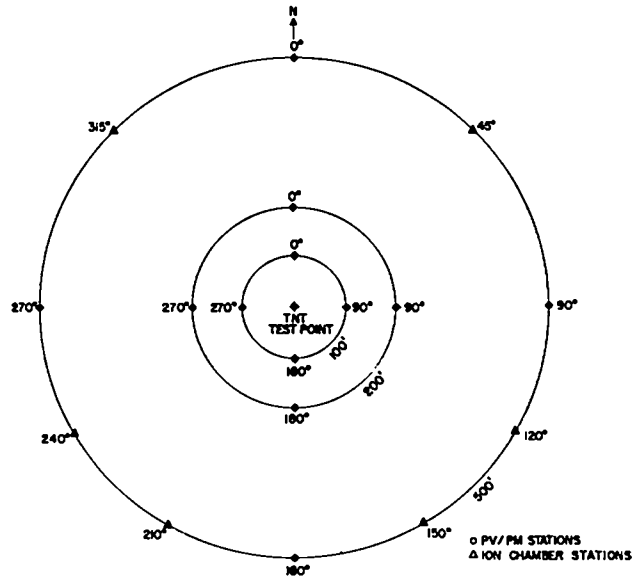

Fig. 10. Location of dose-rate stations, 100 to 500 feet.

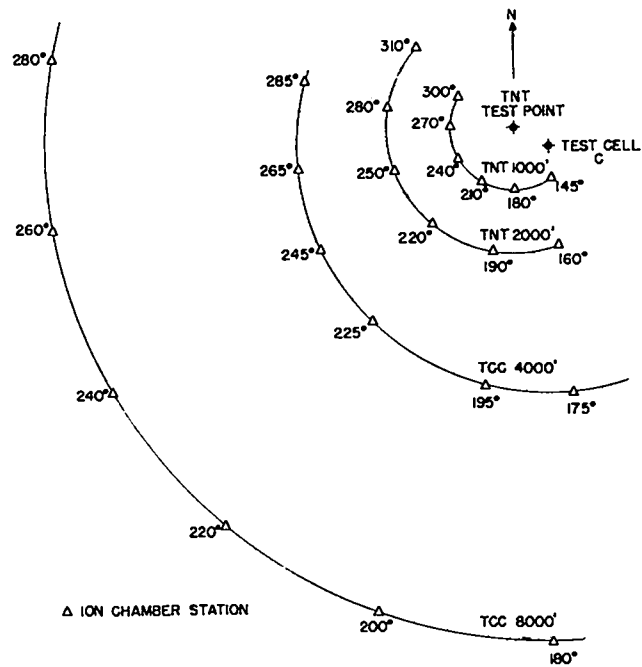

Fig. 11. Location of dose-rate stations, 1,000 to 8,000 feet.

Table 1

CONVERSION TABLE, TEST CELL C 4,000-FOOT AND 8,000-FOOT STATIONS

TCC Designation		TNT Location	
Distance (Feet)	Azimuth (°)	Distance (Feet)	Azimuth (°)
4000	175	4375	168
4000	195	4188	187
4000	225	3875	217
4000	245	3688	237
4000	265	3500	258
4000	285	3375	283
8000	180	8313	176
8000	200	8125	196
8000	220	7875	216
8000	240	7688	236
8000	260	7500	257
8000	280	7438	278

RESULTS

Several of the instruments located close to the TNT test point sustained damage as a result of the transient. This damage was caused by direct hits by missiles and by the shock wave. The PM detector stations seemed to be particularly susceptible to shock damage, undoubtedly owing to the relatively delicate construction of the PM tubes. Recalibration of the PV and PM detectors after the event showed that there was virtually no change in the PV detectors due to use in the TNT event; however, significant changes were observed in the PM detector units. Use of post-event PM unit calibrations resulted in smooth decay curves through the transition from PV to PM detectors for several stations.

Four of the twelve PM detectors failed to respond after the event. Subsequent investigation showed that one on-off line had been damaged by a missile; the other three PM detectors, power supplies, lines, and galvanometers were operational. The causes of the remaining three failures could not be determined.

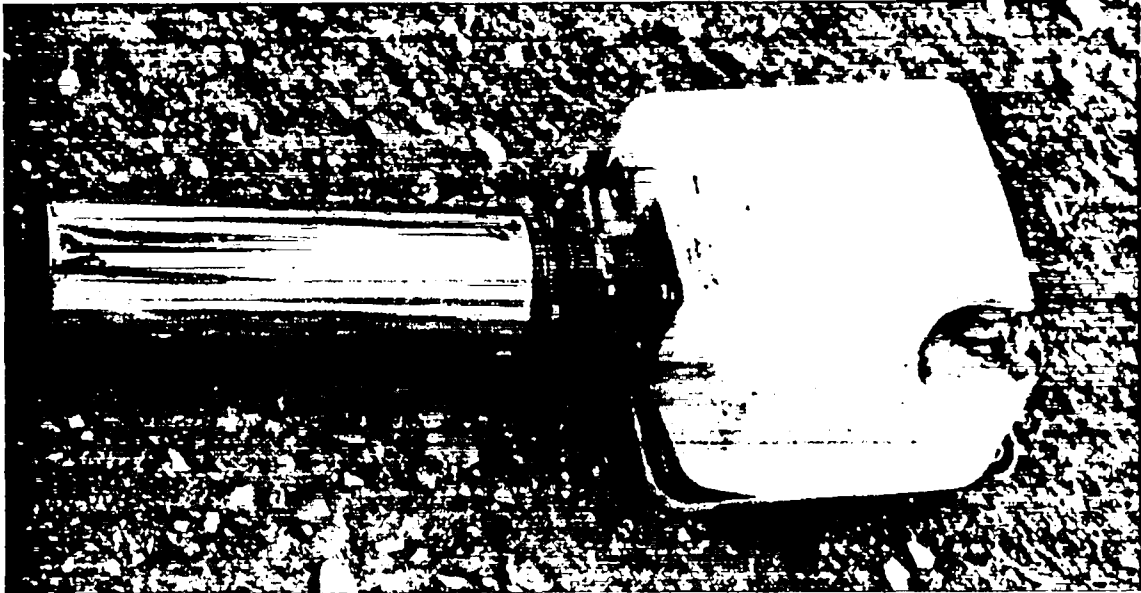

Fig. 12. Ionization chamber probe hit by missile.

Two of the ion chamber stations on the 500-foot arc failed to respond. Three of the four chambers that responded operated in an erratic manner during the first hour and then resumed normal operation. The most notable effect to a station on this arc was a 20 foot radial displacement of the instrument due to a direct hit by a missile (Fig. 12).

Figures 13 through 27 show dose rate at the various instrument stations as a function of time. The length of time during which data were obtained from the individual instruments depended upon individual range limitations, damage, and erratic response. Differences in the rate of decay of the dose rate at various stations were due to the variations in the particular type of debris present.

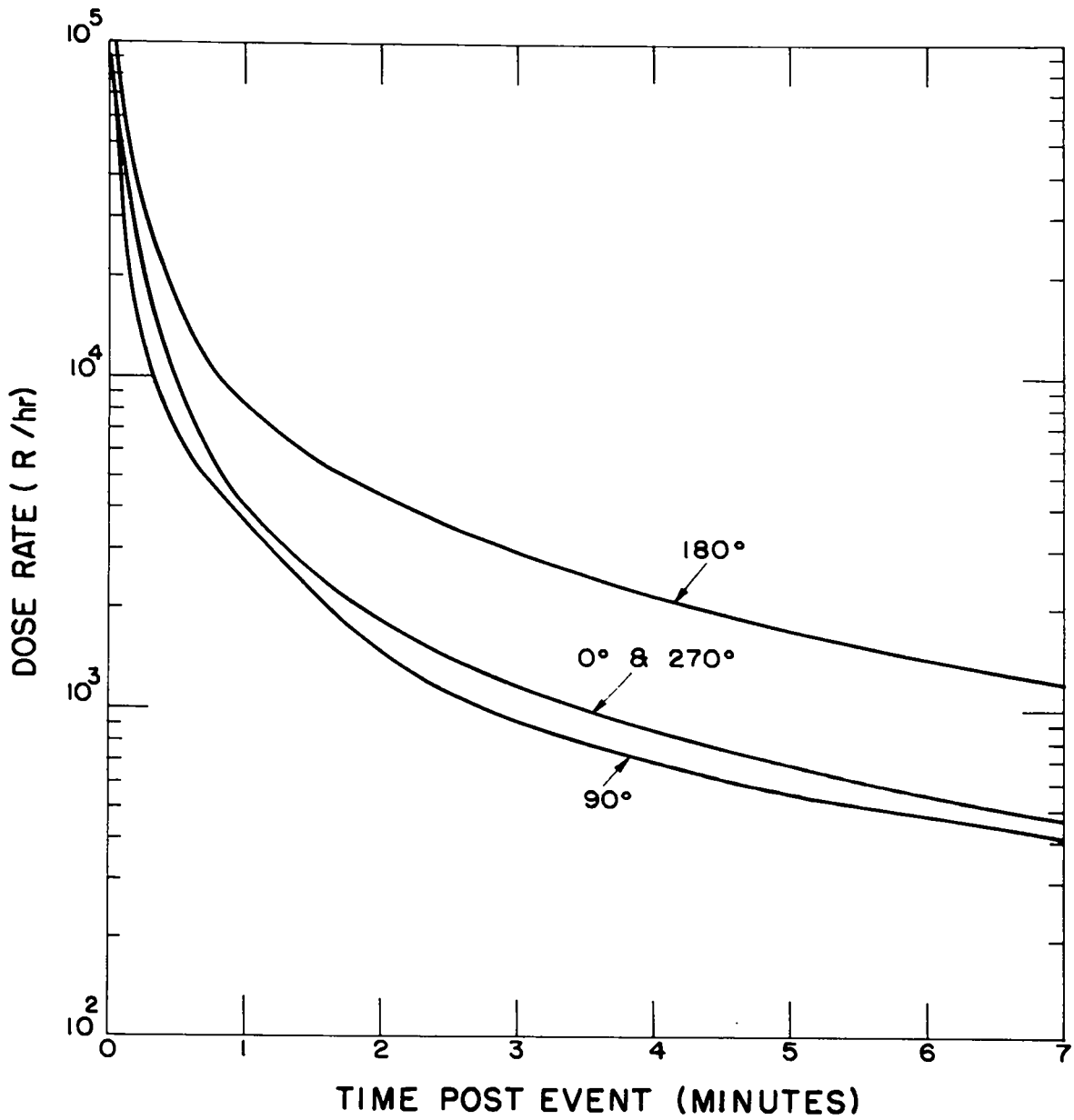

Fig. 13. PV/PM stations at 100 feet.

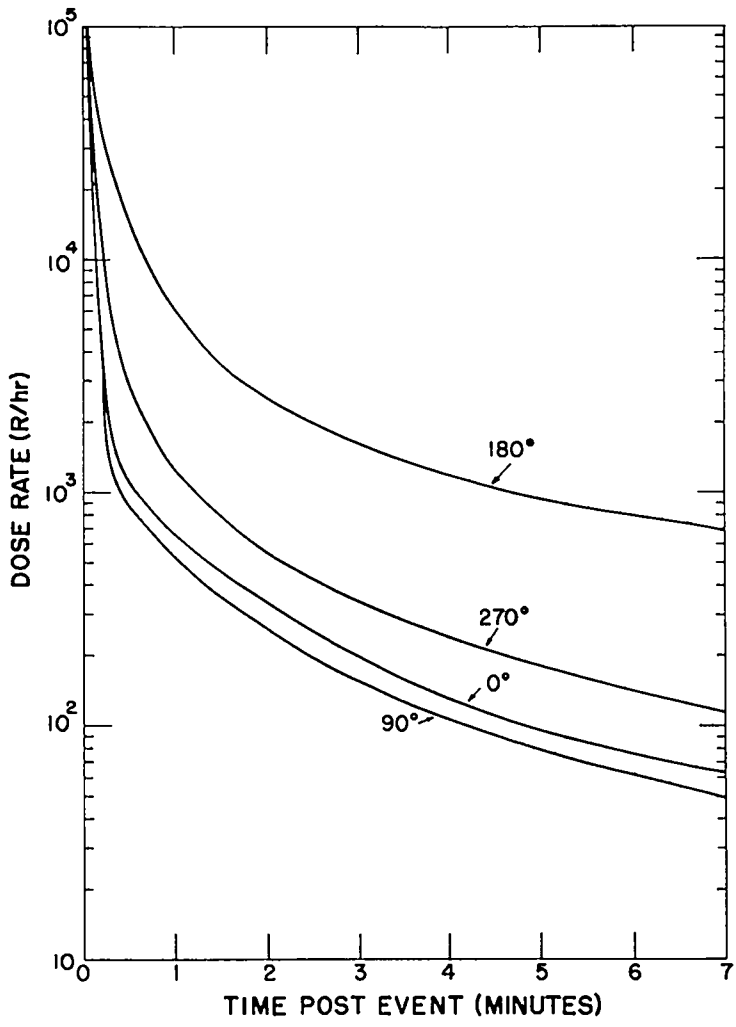

Fig. 14. PV/PM stations at 200 feet.

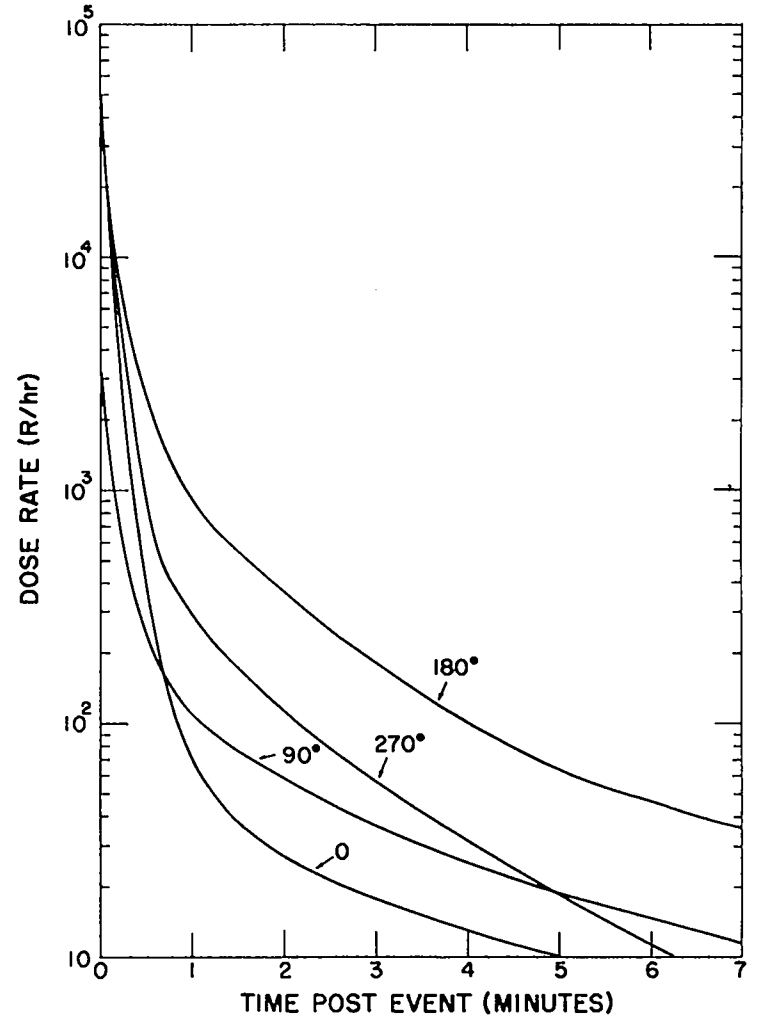

Fig. 15. PV/PM stations at 500 feet.

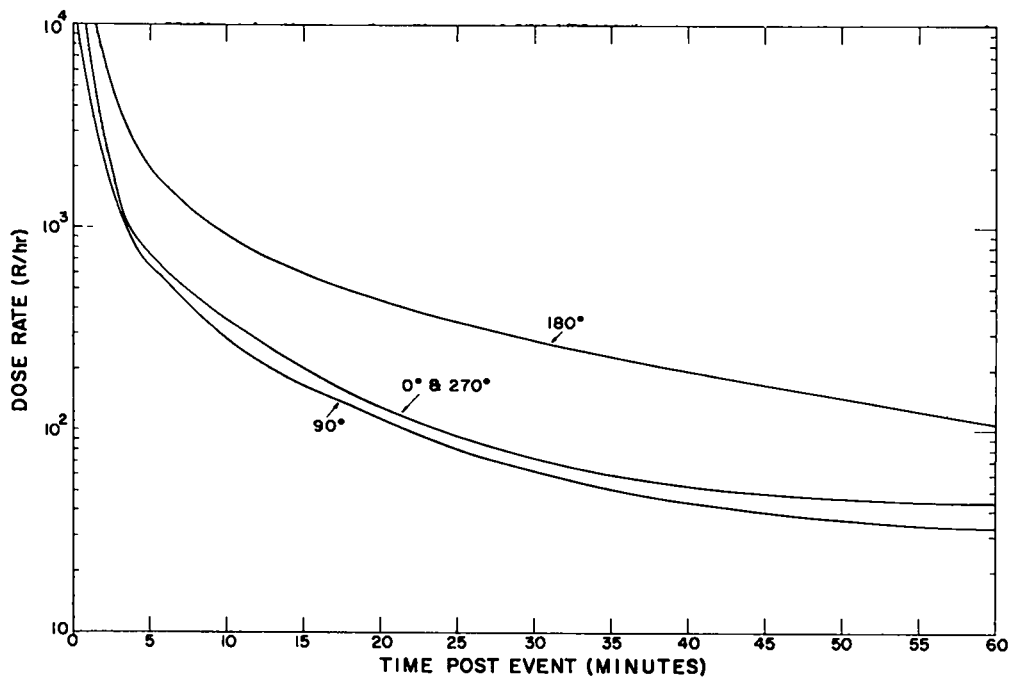

Fig. 16. PV/PM stations at 100 feet.

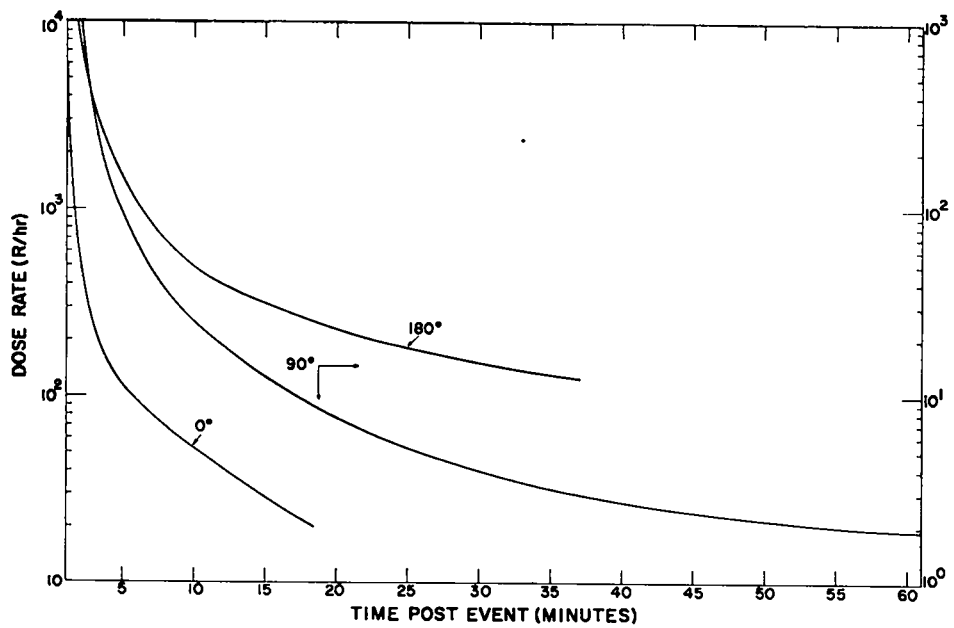

Fig. 17. PV/PM stations at 200 feet.

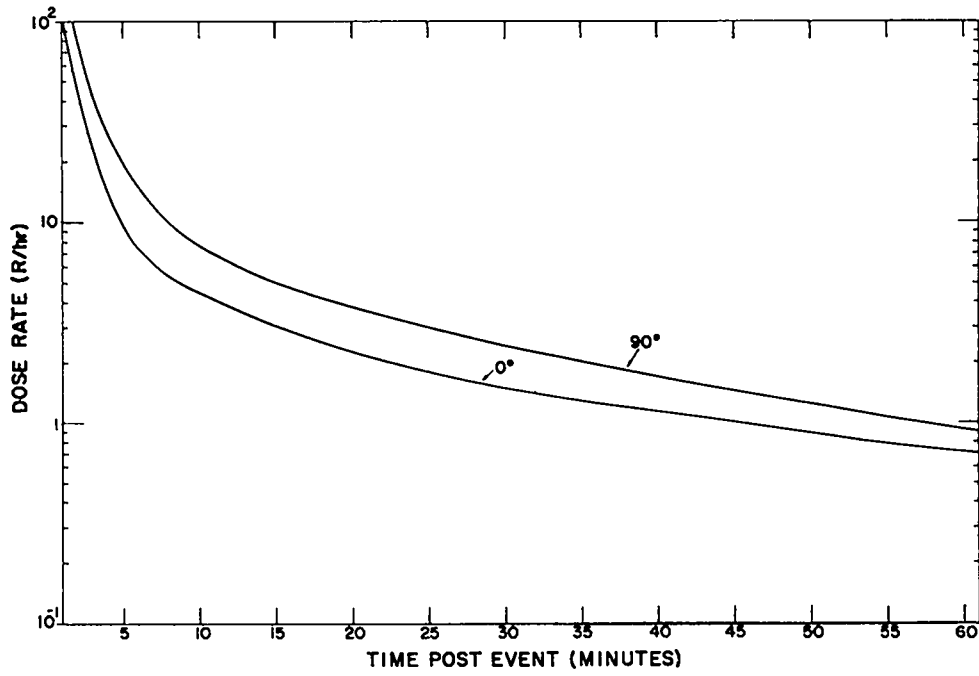

Fig. 18. PV/PM stations at 500 feet.

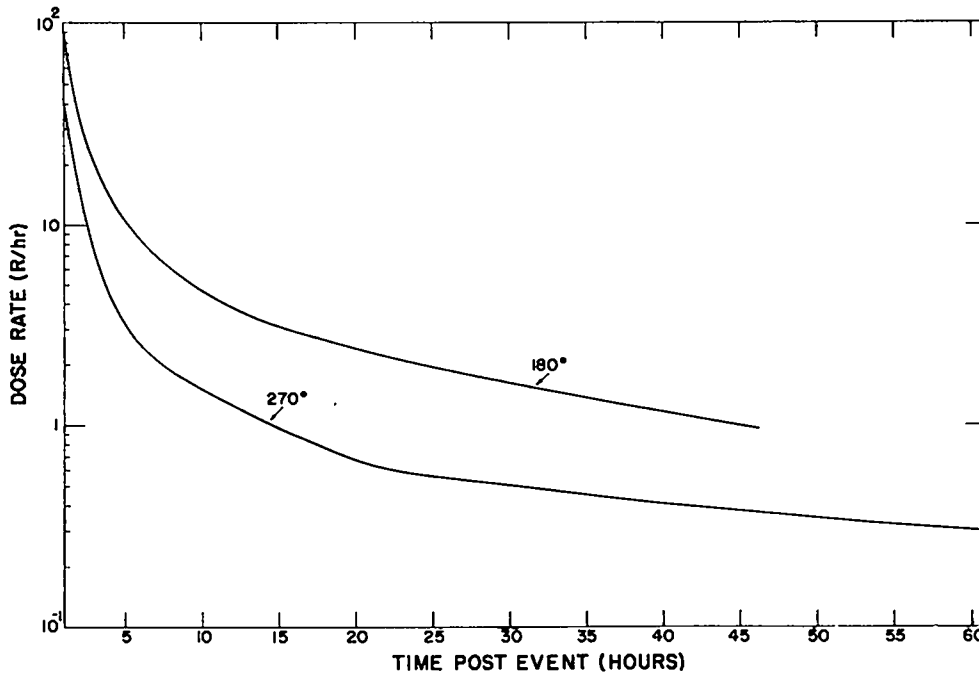

Fig. 19. PV/PM stations at 100 feet.

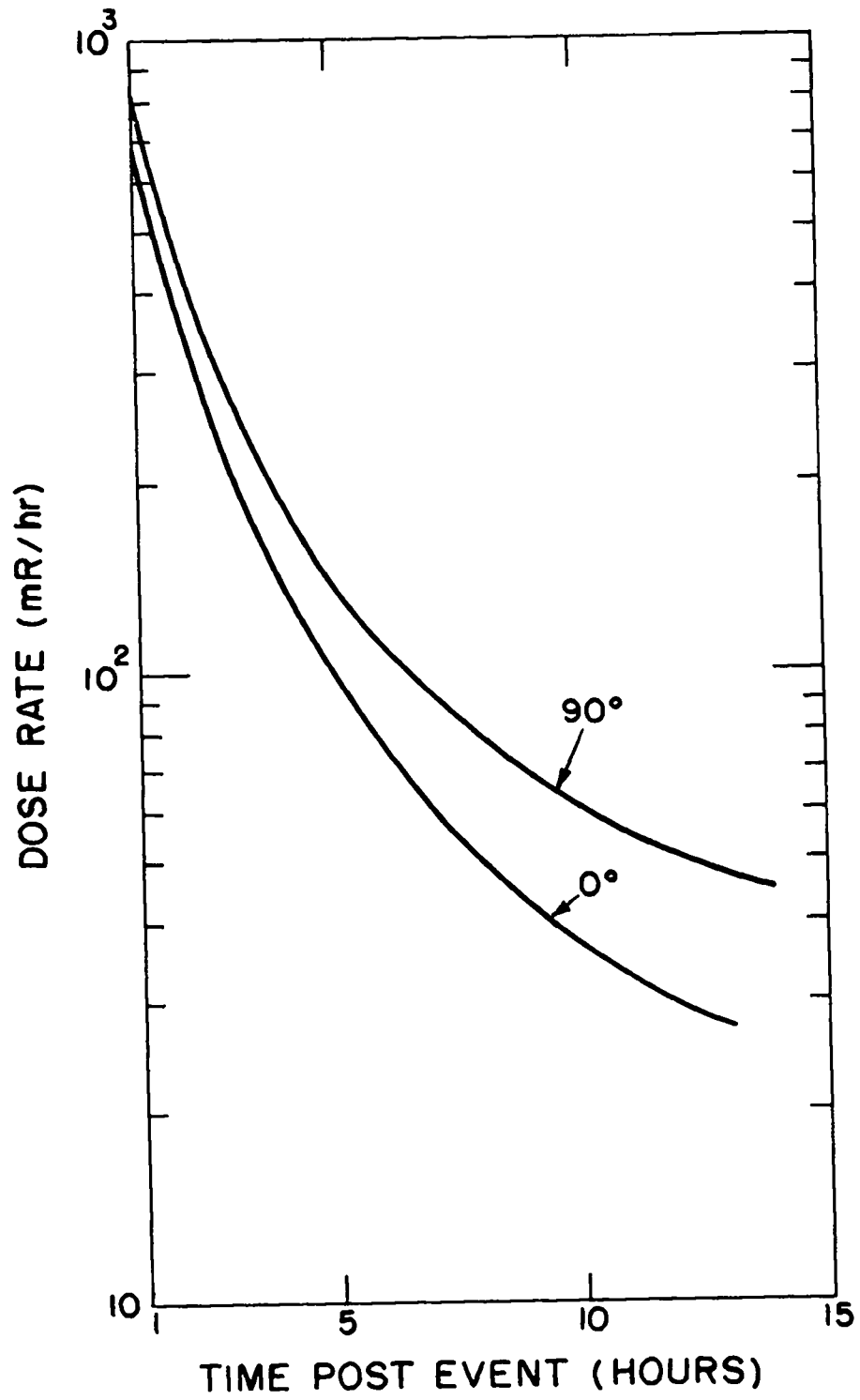

Fig. 20. PV/PM stations at 500 feet.

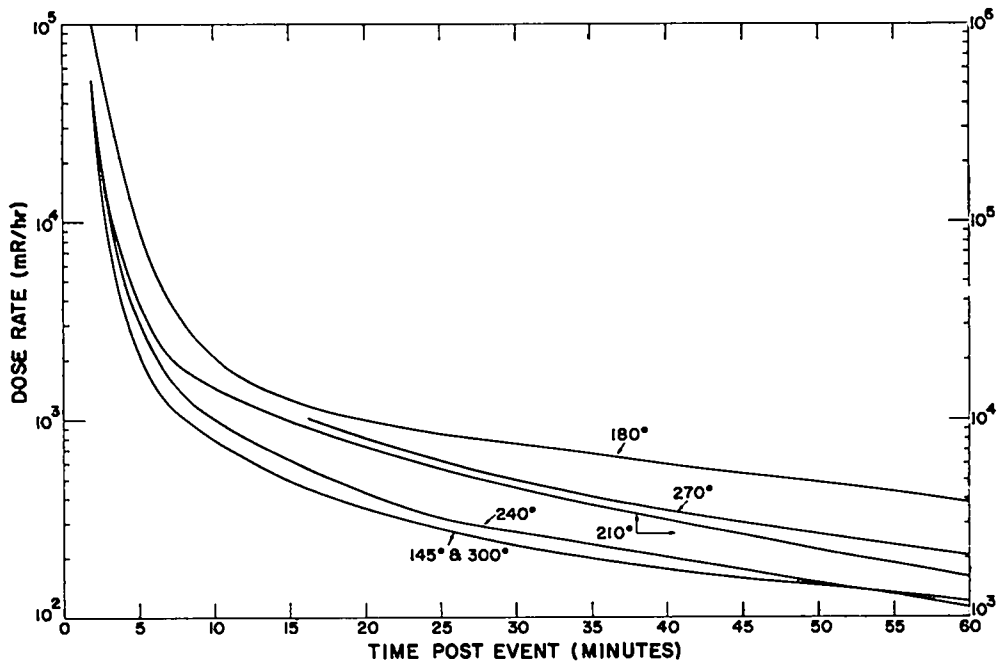

Fig. 21. Ion chamber stations at 1,000 feet.

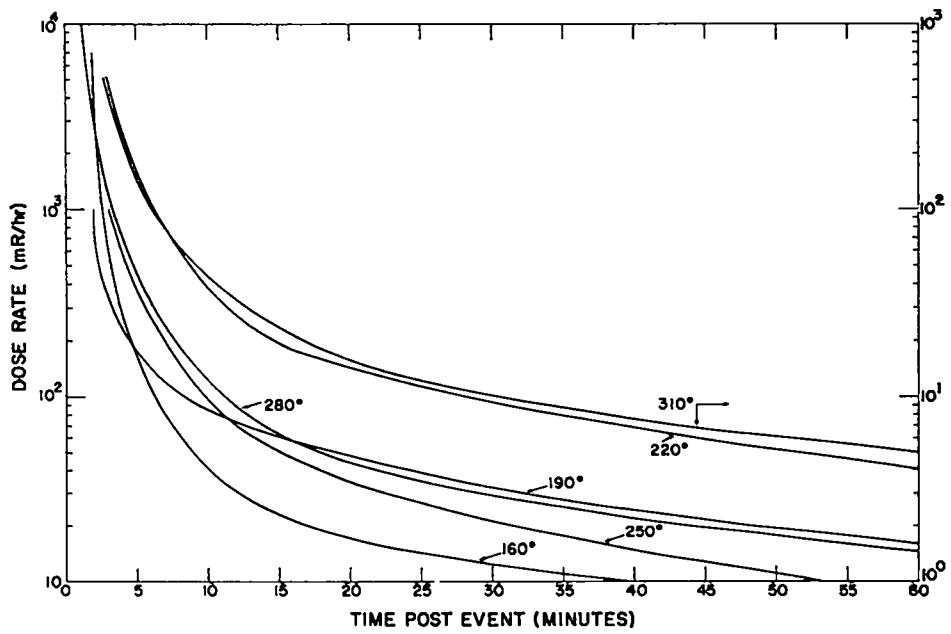

Fig. 22. Ion chamber stations at 2,000 feet.

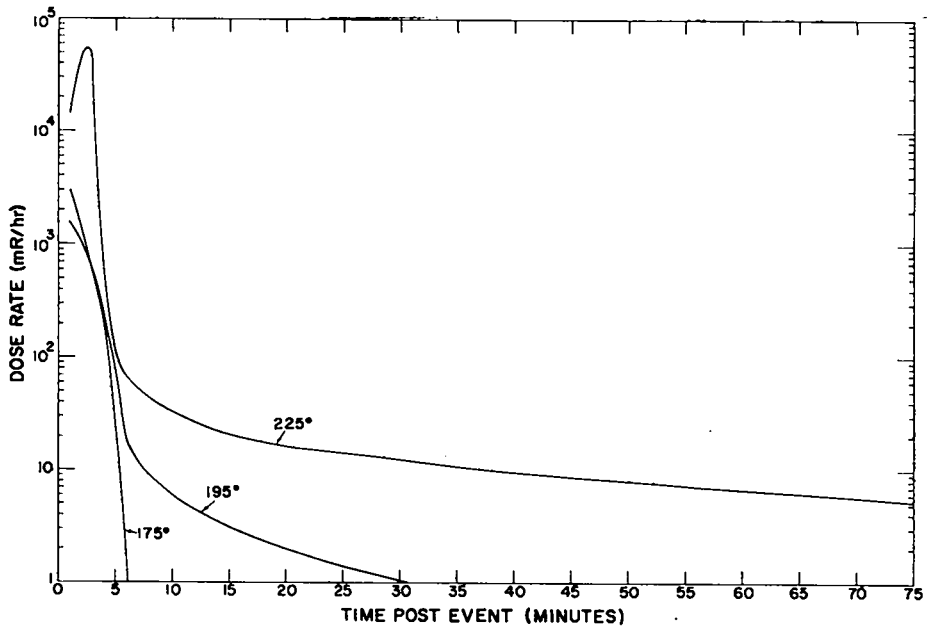

Fig. 23. Ion chamber stations at 4,000 feet.

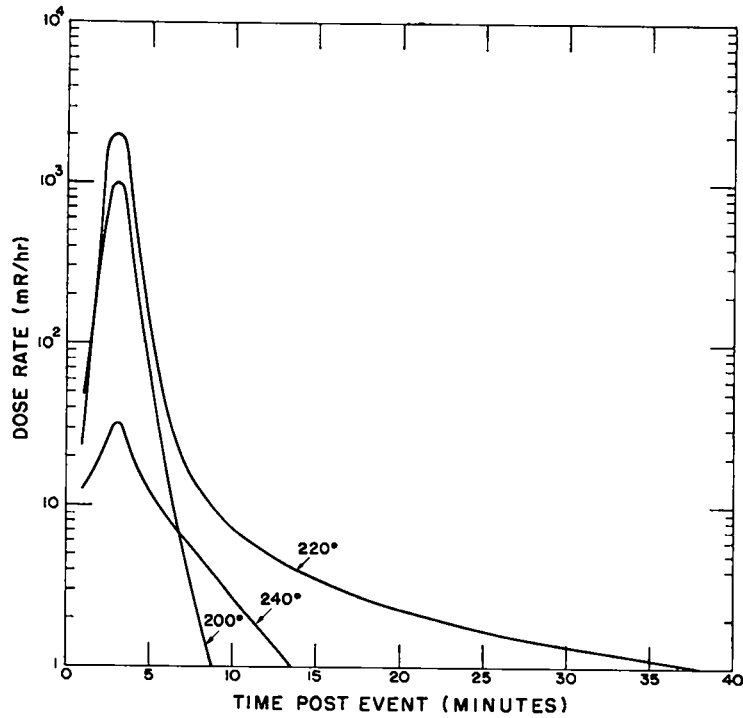

Fig. 24. Ion chamber stations at 8,000 feet.

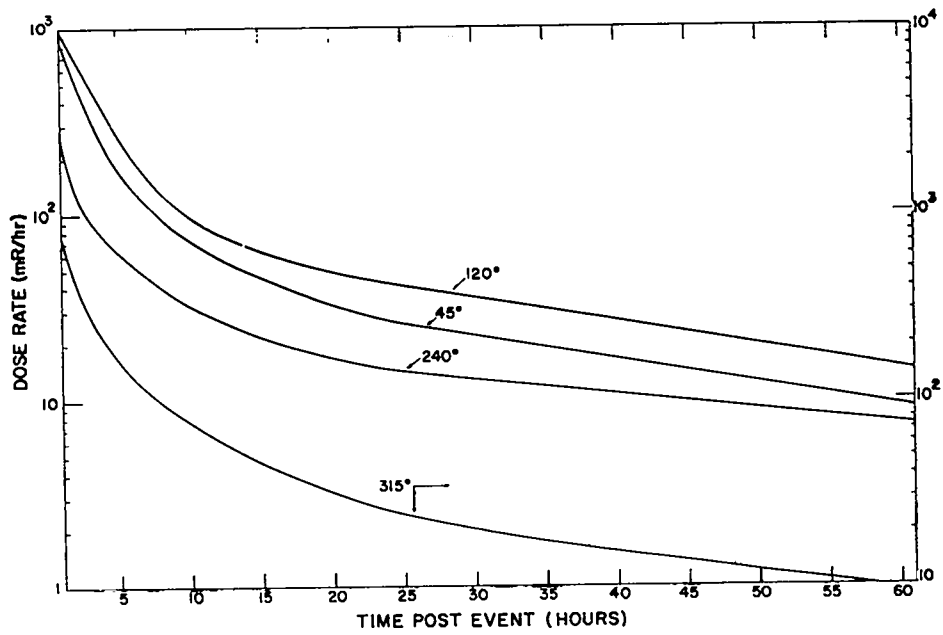

Fig. 25. Ion chamber stations at 500 feet.

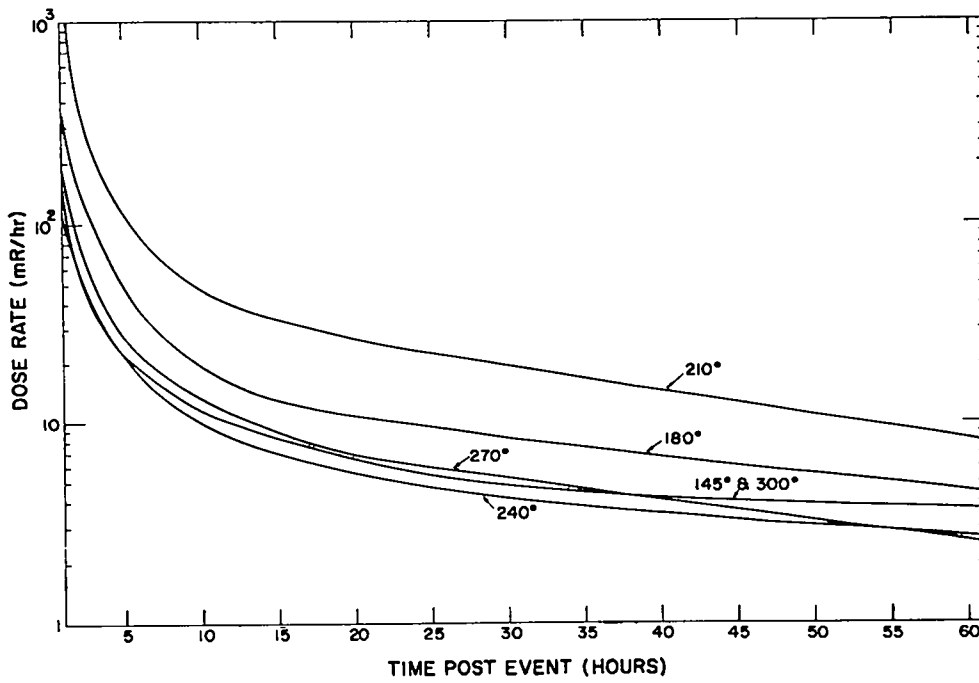

Fig. 26. Ion chamber stations at 1,000 feet.

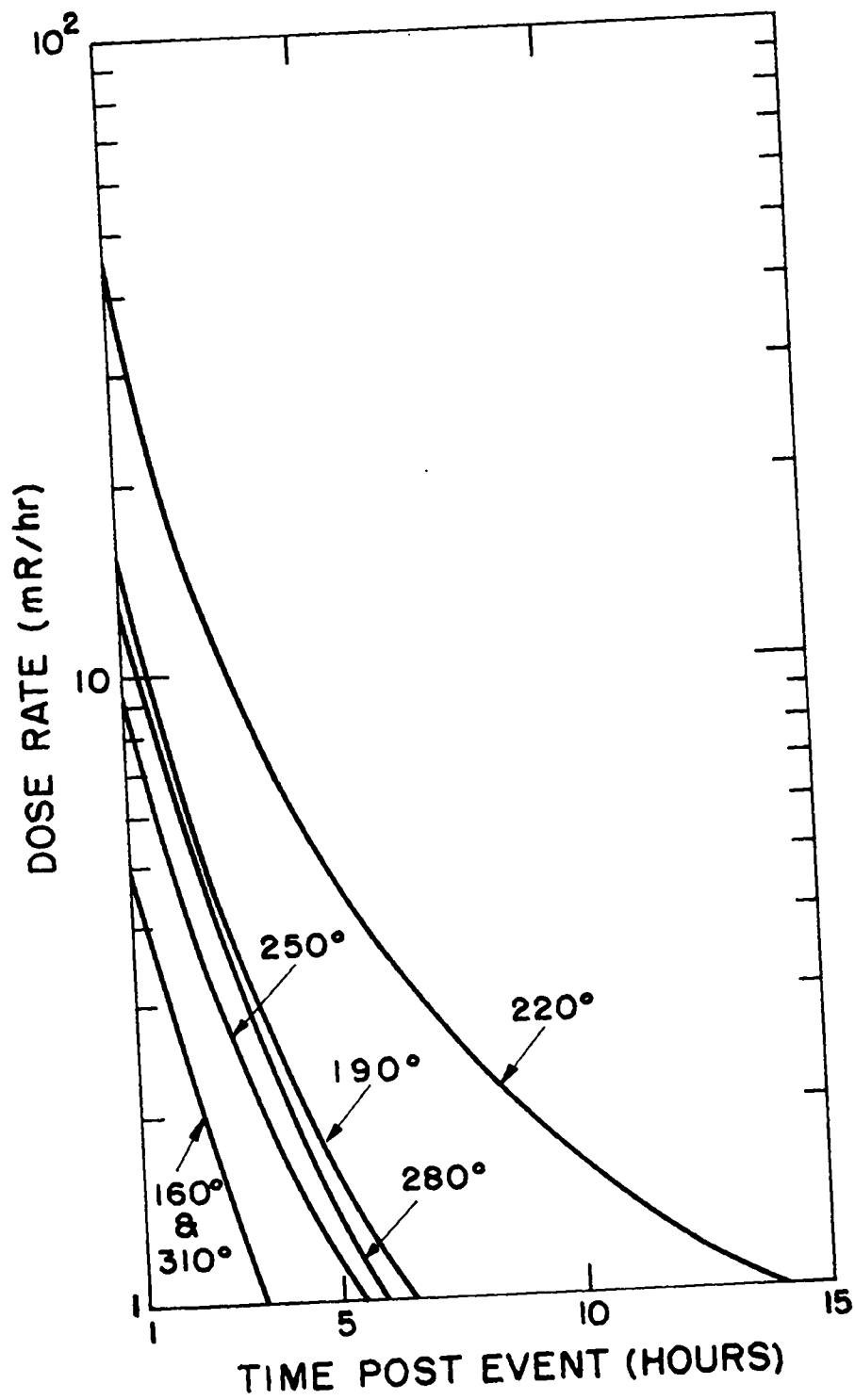

Fig. 27. Ion chamber stations at 2,000 feet.

DISCUSSION

The program of radiation dose rate measurement after the Kiwi TNT event was directed toward evaluation of the radiation hazards existing after the event. The evaluation was complicated by the decision to place the TNT test point in an area with complex terrain features rather than in a flat area.

Figures 28 through 32 show the locations of isodose rate contours at 5, 10, 20, 30, and 60 minutes post event. These dose rate contours were derived from the data presented, through the intermediate steps of preparing dose rate versus distance curves and performing suitable interpolations and extrapolations. The isodose rate contours derived from dose rates measured at 60 minutes post event show good agreement with isodose rate contours extrapolated from ground surveys performed several hours post event.⁴ It is apparent that relatively small areas of high dose rate might not be delineated by a system of fixed instrument stations, whereas a ground survey could locate these areas. A system of instrumented stations does have the advantage of measuring dose rates at short times after an event without any radiation exposure to personnel and without assuming an arbitrary decay rate.

An aspect of the radiation hazard associated with the TNT event which is clearly illustrated by the isodose rate contours is the strong effect of the wind on the deposition of debris. Dose rates at locations of comparable distance upwind and downwind differ by a factor of 10 or more.

The possibility of making emergency entries into an area where a nuclear transient, such as Kiwi TNT, has taken place is of grave concern. To quantitate the hazard involved, two types of entry were evaluated. If an individual were exposed to prompt radiation from the TNT event at a distance of 400 feet, he would have received about 450 rads, a dose that would cause serious injury and entail a 50 percent probability of fatality.² If such an individual had been discovered downwind from the TNT test point immediately after the event, it would not have been possible to rescue him earlier than about 5 minutes post event. Two assumptions were used in calculating the integrated dose to personnel performing such a rescue:

1. A vehicle could average 10 miles per hour after leaving the hard-surfaced road south of Test Cell C.
2. 30 seconds would be required to place the injured person in a vehicle.

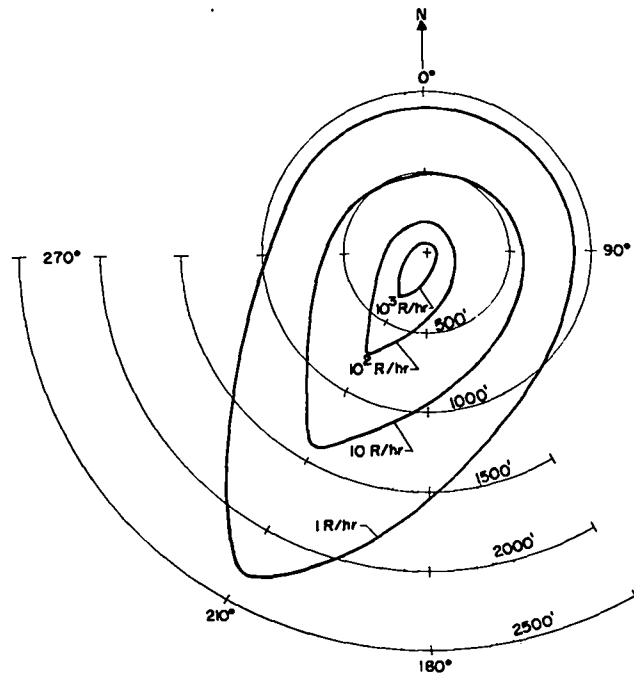

Fig. 28. Isodose rate contours 5 minutes post event.

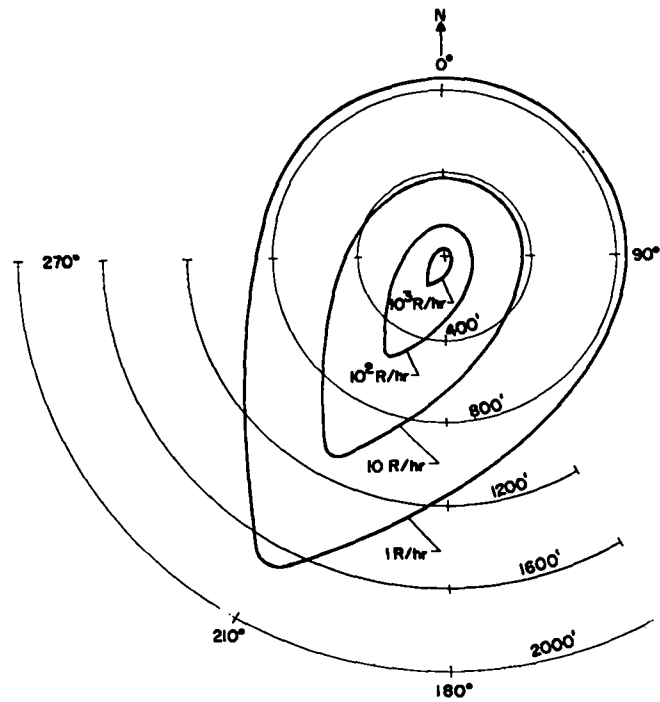

Fig. 29. Isodose rate contours 10 minutes post event.

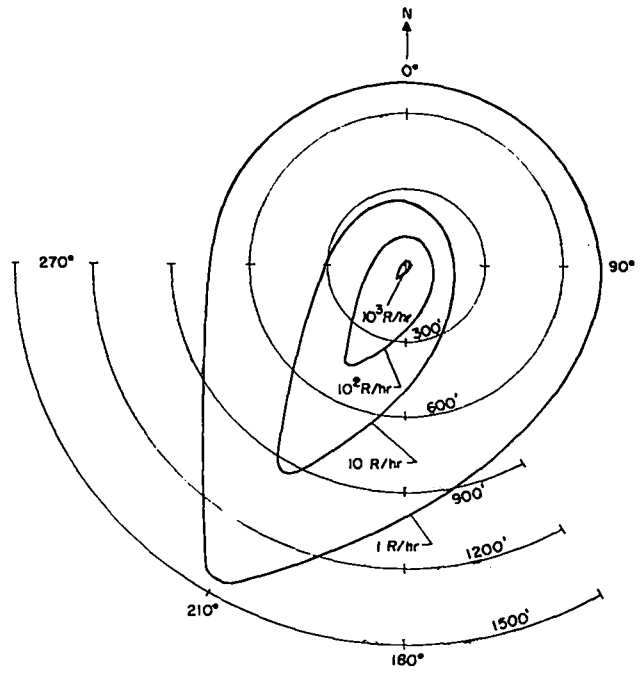

Fig. 30. Isodose rate contours 20 minutes post event.

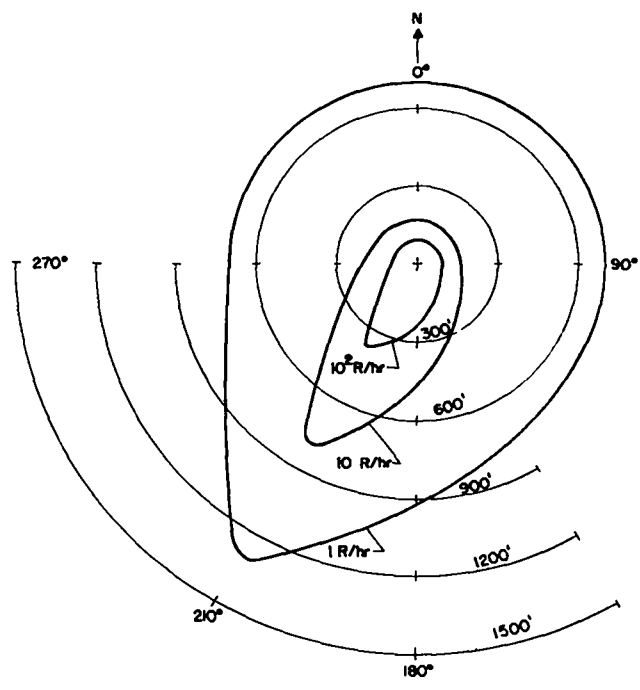

Fig. 31. Isodose rate contours 30 minutes post event.

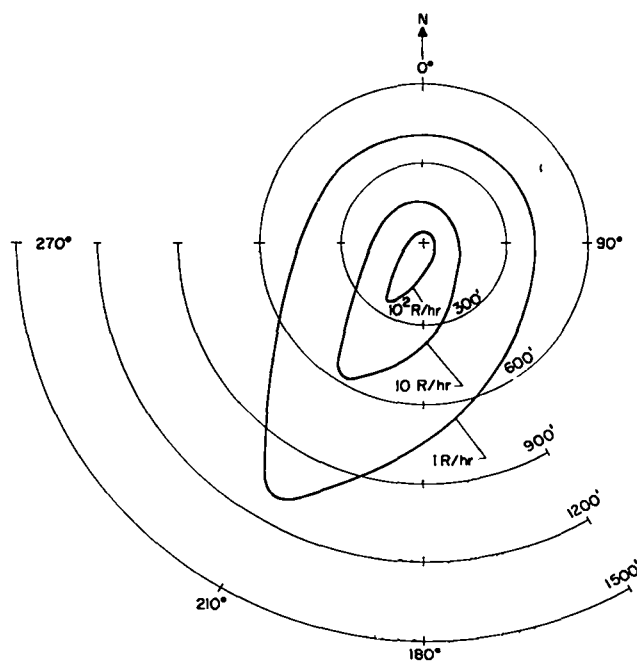

Fig. 32. Isodose rate contours 60 minutes post event.

These assumptions are conservative. Persons performing such a rescue would receive about 6 R of radiation.

The second type of entry evaluated was the rescue of a person who was not exposed to high levels of prompt radiation but somehow subsequent to the transient, proceeded to a location 50 feet downwind from the test point and became immobile. The same assumptions about speed and time required to pick up the injured person were used in the evaluation of this rescue. Table 2 lists integral doses which could have been received if the hypothetical rescues had been performed at various times post event. Doses are subdivided as dose received during transit, dose received during pickup procedure, and total dose. If similar rescue missions had been performed upwind from the TNT test point, the doses involved would probably be a factor of 5 less.

Table 2

INTEGRAL DOSE RECEIVABLE DURING HYPOTHETICAL RESCUE MISSION
DOWNWIND FROM TNT TEST POINT

<u>Time Post Event (Minutes)</u>	<u>Distance From Test Point (Feet)</u>	<u>Dose Received During Transit (R)</u>	<u>Dose Received During Pickup (R)</u>	<u>Total Dose (R)</u>
5	400	2	4	6
5	50	17	33	50
10	50	8	17	25
20	50	4	9	13
30	50	3.5	5.5	9
60	50	1	2	3

CONCLUSIONS

The Kiwi TNT event was a laboriously produced nuclear transient which probably represented the greatest transient that could be produced in a Kiwi-type reactor. It was concluded, on the basis of measurements of dose rate in the area around the TNT test point after the event, that limited emergency entries could have been made into the area within 50 feet of the test point 10 to 20 minutes after the event. These entries could have been accomplished without exceeding 25 R external dose to the personnel involved.

If a similar program of dose rate measurement were to be undertaken again, there should be some changes in the instrumentation system. More effort should be expended in shock mounting detectors and power supplies. More protection against missiles should be provided for detectors and cables.

In general the instruments used performed satisfactorily.

REFERENCES

1. Boasso, C. J., "Core Fragment Study-Kiwi Transient Nuclear Test," Los Alamos Scientific Laboratory Report LA-3445-MS in preparation.
2. Lee, P. K., and F. C. V. Worman, "Integral Gamma and Neutron Measurements on the Kiwi TNT," Los Alamos Scientific Laboratory Report LA-3304, May 1965.
3. Jordan, H. S., "Radiation Measurement of the Effluent From the Kiwi-A Series of Reactors," Los Alamos Scientific Laboratory Report LAMS-2588, June 1961.
4. Fultyn, R., "Environmental Effects of the Kiwi TNT Effluent," Los Alamos Scientific Laboratory Report LA-3449 in preparation.